

A woman with long brown hair, wearing a white knit beanie and a grey knit sweater, is hugging a large tree trunk. She is looking towards the camera with a slight smile. The background is a blurred forest with green and yellow leaves, suggesting an autumn setting. In the top right corner, there is an orange rectangular box containing the brand name 'JELOVICA' in white capital letters. On the left side, there is a list of words in white capital letters: 'WINDOWS', 'FENSTER', 'FINESTRE', '&', 'DOORS', 'TÜREN', and 'PORTE'. In the bottom right corner, the website address 'www.jelovica.si' is written in orange text.

**JELOVICA**

WINDOWS  
FENSTER  
FINESTRE  
&  
DOORS  
TÜREN  
PORTE

[www.jelovica.si](http://www.jelovica.si)



## En route to energy savings

Wooden windows. A touch of nature. Purity and authenticity. With a long tradition. We invite you to explore our website:

[www.jelovica.si](http://www.jelovica.si)

Check out our selection of windows and create an online offer for the selected models and versions.



## Why choose our products?

### Century-old tradition

We've been manufacturing high-quality wooden products since 1905. Our knowledge, perseverance, innovativeness and attitude toward nature are drawn from tradition. We take pride in the trust that our clients have bestowed on us and we are committed to maintaining a high level of trust and confidence.



### Environmentally friendly

The primary material used to manufacture our products is wood. Our manufacturing processes are environmentally responsible and energy self-sufficient and our products are environmentally friendly and recyclable.



### Renowned quality

We are committed to achieving the highest quality standards. The certificates and recognition awards that we have acquired attest to the high quality of our products.



### Extensive experience

Our experience in the installation of windows and doors extends from private new construction projects and renovation projects to large-scale construction projects.



## Mein Weg zum Energiesparen

Holzfenster. Die Berührung der Natur. Reinheit und Echtheit. Mit Tradition. Besuchen Sie unsere Website:

[www.jelovica.si](http://www.jelovica.si)

Prüfen Sie unser Fensterangebot und erstellen Sie sich für die von Ihnen ausgewählten Modelle und Ausführungen ein Onlineangebot.

## Warum Jelovica?

### Hundertjährige Tradition

Bereits seit 1905 produzieren wir qualitativ hochwertige Holzprodukte. Aus der Tradition schöpfen wir Wissen, Ausdauer, unser Verhältnis zur Natur sowie Innovationsfähigkeit. Das Vertrauen unserer Kunden begleitet uns auf unserem Weg und spornt uns an.

### Umweltfreundlich

Holz ist das Grundmaterial unserer Produkte. Sie stammen aus ökologisch und energetisch nachhaltiger Produktion, sind umwelt- und menschenfreundlich und können recycelt werden.

### Anerkannte Qualität

Wir erfüllen die höchsten Qualitätsstandards und belegen diese mit unseren erworbenen Zertifikaten und Auszeichnungen.

### Erfahrungen

Unsere Erfahrungen beim Fenster- und Türereinbau reichen von privaten Neubauten über Renovierungen bis hin zu umfangreichen Objekten.

## Il mio sentiero verso il risparmio energetico

Finestre in legno. Un tocco della natura. Purezza e autenticità. Di tradizione. Visitate il nostro sito internet:

[www.jelovica.si](http://www.jelovica.si)

Verificate la nostra offerta di finestre e elaborate una proposta on-line per i modelli e le realizzazioni selezionati.

## Perché scegliere i prodotti Jelovica?

### Tradizione centenaria

Già dal 1905 creiamo prodotti in legno di qualità, ricavando dalla tradizione il sapere, la tenacia, il rapporto con la natura e l'innovazione. La fiducia dei nostri clienti ci accompagna e ci incoraggia.

### Rispetta l'ambiente

Il legno è il materiale fondamentale dei nostri prodotti. I prodotti nascono da una produzione ecologica e autosufficiente dal punto di vista energetico, rispettano l'uomo e l'ambiente e possono essere riciclati.

### Qualità riconosciuta

Siamo legati ai più alti standard di qualità che possiamo dimostrare con i certificati e i riconoscimenti ricevuti.

### Esperienza

La nostra esperienza in fatto di montaggio di porte e finestre passa dalle nuove costruzioni private alle ristrutturazioni, fino agli edifici più esigenti.





Wood. There is nothing in the world that provides us with such warmth and completeness as wood does. It keeps us warm and protects us. It can be used to build a roof over our heads or a bed to lie down on. It provides us with sure footing, warm meals and the most beautiful sounding musical instruments. Wood is used to build bridges that connect people and places, and it provides protection from the cold. Of all the wonders of nature, wood is the thing that humans have always been most attached to. That is why wood has been the focal point of our and your story for more than a hundred years.

We have been manufacturing wooden products **since 1905** and we take pride in our tradition of developing and designing energy-saving building furniture and houses. Today, each window and door goes through a technologically advanced and carefully controlled manufacturing process to ensure they meet the highest standards for energy efficiency, sustainability and quality of life.

Our foundations are based on a strong wood-working tradition. At the same time, we are also future oriented, with a maximum level of respect for the environment.

Wood symbolises a cosy home.  
Wood also symbolises Jelovica.  
Since 1905.

Holz. Nichts auf der Welt durchdringt unser Leben mit einer solchen Wärme und Vollkommenheit wie Holz. Es wärmt uns und schützt uns. Einmal ist es für uns ein Dach über dem Kopf und einmal das Bett unter uns. Holz ermöglicht uns sichere Schritte, eine warme Mahlzeit und die schönsten Töne aus Instrumenten. Holz verbindet uns durch Brücken und schützt uns vor Kälte. Auch deshalb ist der Mensch seit jeher unter allen Wundern der Natur am meisten mit Holz verbunden. Und auch aus diesem Grund stellt Holz schon seit mehr als einhundert Jahren das Zentrum unserer und Ihrer Geschichte dar.

Bereits **seit 1905** leben wir mit Holz und können auf eine ruhmreiche Tradition der Entwicklung und Gestaltung von energiesparenden Holzbauteilen und Häusern zurückblicken. Heute geht jedes Fenster und jede Tür durch einen technologisch ausgereiften und sorgfältig überwachten Produktionsprozess, der gewährleistet, dass in Bezug auf Energiesparsamkeit, Haltbarkeit und Wohnqualität die höchsten Ansprüche erfüllt werden.

Unser Fundament besteht aus einer reichen Tradition der Holzverarbeitung, wobei wir gleichzeitig mit Respekt gegenüber der Umwelt auf die Zukunft ausgerichtet sind.

Holz ist ein Zuhause.  
Holz ist auch Jelovica.  
Schon seit 1905.

Il legno. Nulla al mondo avvolge la nostra vita con tale calore e perfezione come il legno. Ci riscalda. Protegge. Talvolta funge da tetto sopra le nostre teste, altre volte è il letto sotto di noi. Ci permette di fare passi sicuri, di cucinare pasti caldi e di ricavare i più bei suoni dagli strumenti. Il legno ci collega con i ponti e ci ripara dal freddo. Anche per questo motivo, tra tutte le meraviglie della natura, l'uomo è da sempre affezionato soprattutto al legno. Ed è anche per questo che il legno da oltre cent'anni è il nucleo della nostra e della vostra storia.

Già **dal 1905** viviamo con il legno e possiamo vantare di una tradizione dello sviluppo e del design dei mobili e delle case a risparmio energetico. Oggigiorno, ogni finestra e ogni porta attraversano un processo di produzione tecnicamente perfezionato e rigidamente controllato, capace di garantire il raggiungimento delle più alte esigenze di efficienza energetica, della sostenibilità e della qualità di vita.

Le nostre basi sono radicate in una ricca tradizione del legno, ma, nel rispetto dell'ambiente, allo stesso tempo siamo orientati verso il futuro.

Il legno è casa.  
Il legno è anche Jelovica.  
Già dal 1905.



## ENERGY-SAVING

Wood is a natural material which performs exceptionally well as an insulation material and can significantly reduce heating and cooling costs. The  $U_w$  index is used to measure temperature changes.

**A  $U_w$  index of  $\leq 0.8 \text{ W/m}^2\text{K}$**  is a measure for the highest quality **PASSIVE WINDOWS**.

With poor quality windows, we may lose up to 40% of the energy.

## ENERGIESPAREND

Holz ist ein natürliches Material mit außerordentlichen Isoliereigenschaften und bringt Ersparnisse bei Heiz- und Kühllkosten. Der Temperaturverlust wird mit dem  $U_w$ -Index gemessen.

**Ein  $U_w$ -Index von  $0,8 \text{ W/m}^2\text{K}$  oder weniger** zeichnet die qualitativ hochwertigsten **PASSIVFENSTER** aus.

Bei Fenstern von schlechter Qualität kann der Energieverlust sogar bis zu 40 % betragen.

## RISPARMIO ENERGETICO

Il legno è un materiale naturale con una straordinaria capacità di isolamento che apporta un risparmio nei costi di riscaldamento e di raffreddamento. La perdita di temperatura si misura con l'indice  $U_w$ .

**L'indice  $U_w \leq 0,8 \text{ W/m}^2\text{K}$**  è la misura per le **FINESTRE PASSIVE** di massima qualità.

Con le finestre di bassa qualità si può perdere anche fino al 40% di energia.

# Wood. Choose Life! Holz. Wählen Sie das Leben. Il legno. Scegliete la vita.



## FIRE SAFE

Contrary to common belief, wood offers even greater fire resistance than concrete because charred pieces of wood act as a natural shield. In the event of a fire, wood does not emit toxic gases and wooden windows remain structurally stable for a longer period of time.

## BRANDSICHERHEIT

Im Gegensatz zu der weitläufigen Ansicht bietet Holz sogar eine höhere Brandsicherheit als Beton, denn die verkohlten Holzteile wirken als natürlicher Schutz. Im Brandfall gibt Holz keine giftigen Gase ab und Holzfenster behalten für längere Zeit ihre Konstruktionsstabilität.

## SICURO CONTRO GLI INCENDI

Al contrario della convinzione comune, il legno offre una resistenza contro il fuoco anche maggiore del calcestruzzo, poiché le parti carbonizzate del legno funzionano come uno scudo naturale. In caso di incendio, il legno non emette gas tossici e la struttura delle finestre in legno rimane stabile più a lungo.



## SUSTAINABLE

Products made of wood have a long lifespan and often their quality even increases over the years.

**Aluminium cladding** on the outside of the window provides extra protection, so no additional maintenance is required and the window's lifespan is extended.

## NACHHALTIG

Produkte aus Holz haben eine lange Lebensdauer und mit den Jahren verbessert sich häufig noch ihre Qualität.

**Die Aluminiumhülle** auf der Außenseite schützt das Fenster zusätzlich, daher ist keine zusätzliche Instandhaltung notwendig und die Lebensdauer des Fensters wird verlängert.

## SOSTENIBILE

I prodotti in legno hanno una lunga vita e spesso con il passare degli anni aumentano anche la loro qualità.

**Lo strato in alluminio** nella parte esteriore protegge ulteriormente la finestra, perciò non c'è bisogno di altra manutenzione e la vita della finestra si allunga.



## HEALTHY

Wood is a living material that breathes and helps create the conditions for a healthy living environment as it regulates the relative humidity in the room and is not electrostatic.

**Plastic windows** seal up a space, preventing air flow and creating high levels of humidity in the room.

## GESUND

Holz ist ein lebendiges Material und schafft Bedingungen für ein gesundes Wohnen, denn es reguliert die relative Luftfeuchtigkeit in den Räumen und ist nicht elektrostatisch.

**Kunststofffenster** verschließen den Raum luftundurchlässig und führen zu Feuchtigkeit im Raum.

## SALUBRE

Il legno è un materiale vivo che respira e aiuta a creare le condizioni per una vita sana, regolando l'umidità relativa dell'ambiente senza elettrostatica.

**Le finestre in plastica** chiudono lo spazio ermeticamente, creando umidità nell'ambiente.



## ECOLOGICAL

Cleaner production processes with lower energy consumption and CO<sub>2</sub> emissions compared to plastic windows. Wood can be recycled and reused.

All wood used in the manufacture of our products is of **Slovenian origin**. Wood is biodegradable. When 'New for Old' windows are ordered, we make sure the discarded windows are disposed of in an ecologically sound manner.

## ÖKOLOGISCH

Im Vergleich zu Kunststoffen ist ihre Herstellung sauberer, verbraucht weniger Energie und der CO<sub>2</sub>-Ausstoß ist geringer. Holz kann recycelt und erneut verwendet werden.

Das gesamte für unsere Produkte verwendete Holz ist **slowenischer Herkunft**. Holz ist biologisch abbaubar. Bei einer Bestellung »Alt für Neu« sorgen wir für die umweltgerechte Entsorgung der alten Fenster.

## ECOLOGICO

Una produzione pulita con minore consumo di energia e meno emissioni di CO<sub>2</sub> in confronto alle finestre in plastica. Il legno può essere riciclato e usato nuovamente.

Tutto il legno usato per i nostri prodotti è di **origine slovena**. Il legno è biodegradabile. Se scegliete di rottamare le finestre usate, provvediamo al loro deposito ecologico.

# We use our knowledge to select. We follow our hearts to make a final choice.

Your decision to choose windows, doors or other products manufactured by Jelovica is not just a decision of the heart. The arguments in favour of this decision are actually quite convincing.

# Wählen Sie mit Wissen aus. Und entscheiden Sie sich mit dem Herzen.

Die Entscheidung für Fenster, Türen und andere Produkte von Jelovica ist nicht nur eine Entscheidung Ihres Herzens. Die Entscheidungsargumente überzeugen auch in der Praxis.

# Scegliamo con il sapere. Decidiamo con il cuore.

La decisione di scegliere le finestre, le porte e altri prodotti Jelovica non è solo una decisione del vostro cuore. Gli argomenti a favore di questa decisione sono convincenti anche dal punto di vista pratico.



## Energy efficiency

The lowest  $U_w$  index possible

The  $U_w$  index and temperature readings are used to measure energy efficiency. A lower  $U_w$  index means that the windows allow less heat transfer and are more energy efficient. Various models of Jelovica windows fall under the category of higher and even the highest energy-saving windows.

The **Jelopasiv** windows from the **Pasiv** line have a  **$U_w$  index of  $\leq 0.8$**  and have obtained the highest mark of quality in terms of energy and sustainability (a fir tree with a dark green star).

## Energieeffizienz

Ein so geringer  $U_w$ -Index wie möglich.

Die Energieeffizienz wird mit dem  $U_w$ -Index gemessen. Ein geringerer  $U_w$ -Index bedeutet eine geringere Wärmedurchgängigkeit des Fensters und eine größere Sparsamkeit. Verschiedene Fenstertypen von Jelovica gehören in die gehobene und höchste Gruppe von Energiesparfenstern.

Die Fenster **Jelopasiv** aus dem Verkaufsprogramm **Pasiv** haben einen  **$U_w$ -Index von  $\leq 0,8$**  und in Bezug auf die Energiespar- und Nachhaltigkeitsqualitäten die höchste Auszeichnung.

## Efficienza energetica

l'indice  $U_w$  più basso possibile

L'efficienza energetica è misurata con l'indice  $U_w$  di perdita della temperatura. Un minore indice  $U_w$  significa una minore trasmittanza termica della finestra e con questo maggiore economicità. Diversi modelli di finestre Jelovica rientrano nel gruppo di finestre a risparmio energetico alto e più alto.

Le finestre **Jelopasiv** con l'indice  **$U_w \leq 0,8$**  della linea **Pasiv** hanno il marchio più alto di qualità energetica e di sostenibilità, «l'abete con una stella verde scuro».







## Material

Wood or Wood+Aluminium

**WOOD** • We usually use spruce wood as the basic material for our wooden windows as it has the best thermal insulation properties. You can choose between larch and oak wood, depending on your colour choice.

**WOOD + ALUMINIUM** • These windows are made in a combination of wood with an aluminium cladding on the outer side, which gives the wood extra protection against weather conditions, and need hardly any additional maintenance.

## Material

Holz oder Holz + Aluminium

**HOLZ** • Das Grundmaterial für Holzfenster ist meistens Fichtenholz, weil dieses über die besten Wärmeisolationseigenschaften verfügt. Je nach den farblichen Anforderungen können Sie sich auch zwischen Lärchen- oder Eichenholz entscheiden.

**HOLZ + ALUMINIUM** • Fenster in der Kombination aus Holz und Aluminium auf der Außenseite, die das Holz zusätzlich vor Witterungseinflüssen schützt, benötigen praktisch keine zusätzliche Instandhaltung.

## Materiale

Legno o legno + alluminio

**LEGNO** • La base più comunemente usata per le finestre è il legno di abete, che presenta le migliori caratteristiche di isolamento termico. Secondo le esigenze di colore potete scegliere anche tra il legno di larice o di rovere.

**LEGNO + ALLUMINIO** • Le finestre in combinazione di legno e maschera di alluminio sulla parte esterna, che protegge ulteriormente il legno dalle condizioni meteorologiche, praticamente non hanno bisogno di ulteriore manutenzione.



## Quality and Warranty

Sturdy construction - guaranteed durability

Jelovica windows are constructed with cut and bonded angles. This ensures that our windows are extremely strong and have exceptional static stability. The large bonding surface makes the cut and bonded angles strong and sturdy, and the bond extends the window's lifespan. The warranty period for wooden and wood-aluminium windows is 5 years. The warranty period for doors is 2 years.

The frequency of subsequent maintenance depends on the windows' exposure to sun or humidity.

## Qualität und Haltbarkeit

Stabile Konstruktion - Garantierte Lebensdauer der Fenster

Die Fenster von Jelovica werden mit einer Nut-Winkel-Verbindung hergestellt, die außerordentlich stabil ist und eine hervorragende statische Stabilität der Fenster gewährleistet. Diese Nut-Winkel-Verbindung erhält ihre Stabilität durch die große Kleboberfläche, und die Verbindung verlängert die Lebensdauer des Fensters. Auf Holz- und Holz-Alu-Fenster geben wir 5 Jahre Garantie. Auf Eingangstüren geben wir 2 Jahre Garantie.

Die Häufigkeit von nachträglichen Instandhaltungsarbeiten ist davon abhängig, in welchem Maße das Fenster der Sonne oder Feuchtigkeit ausgesetzt ist.

## Qualità e sostenibilità

Costruzione solida - durabilità garantita

Le finestre Jelovica sono composte da una giunzione ad incastro angolare estremamente forte che garantisce un'eccezionale stabilità statica delle nostre finestre. La solidità della giunzione ad incastro angolare deriva dalla grande superficie di incollaggio, allungando la vita della finestra. Il periodo di garanzia delle finestre in legno e in legno-alluminio è di 5 anni. Per porte d'ingresso offriamo 2 anni di garanzia.

La frequenza della successiva manutenzione dipende dall'esposizione della finestra al sole o all'umidità.



## Glazing

Double or triple layer glass

The triple layer insulating glass that we install in Jelovica windows consists of a middle glass panel made of float glass and two outer glass panels with low-emission coating. Both spaces in between the glass panels are filled with gas to improve insulation against heat transfer.

Passive windows with **high performance insulating glass** meet the highest energy standards.

## Verglasung

Dreifach- oder Zweifachverglasung

Die dreifache Wärmeschutzverglasung, die wir in die Jelovica-Fenster einbauen, besteht standardmäßig aus dem mittleren Floatglas und zwei Gläsern mit Niedrigemission. Die zwei Räume zwischen den Gläsern sind mit Gas gefüllt und stellen für die Wärmedurchgängigkeit eine doppelte Barriere dar.

Passivfenster mit **Wärmeschutzverglasung** erfüllen die höchsten Energiesparstandards.

## Vetraggio

a strato doppio o triplo

I vetri isolanti a tre strati che vengono installati nelle finestre Jelovica sono composti in modo standard dal vetro centrale 'float' e da due vetri con applicazioni a bassa emissione. I due spazi tra i vetri sono riempiti con gas e costituiscono una doppia barriera per il trasferimento del calore.

Finestre passive **con vetro ad alta capacità di isolamento** per soddisfare i più elevati standard energetici.





Windows / Fenster / Finestre

## 4 > Jeloterm



### Jeloterm Premium

**GLAZING / VERGLASUNG / VETRAGGIO**  
double glazing 4-16-4 / Doppelverglasung  
4-16-4 / vetro doppio 4-16-4

**WOODEN PROFILE + ALU CLAD /  
HOLZPROFIL + ALUMASKE / PROFILO IN  
LEGNO + MASCHERA IN ALLUMINIO**  
85 mm

**MATERIAL / MATERIAL / MATERIALE**  
spruce, larch, oak / Fichte, Lärche, Eiche /  
abete, larice, rovere

**ENERGY EFFICIENCY / WÄRMEDÄMMWERT/  
EFFICIENZA ENERGETICA**  
 $U_g = 1,1 \text{ W/m}^2\text{K}$ ,  $U_w = 1,3 \text{ W/m}^2\text{K}$

$U_w \leq 1,3$



### Jelotech

**GLAZING / VERGLASUNG / VETRAGGIO**  
double glazing 4-16-4 / Doppelverglasung  
4-16-4 / vetro doppio 4-16-4

**WOODEN PROFILE / HOLZPROFIL /  
PROFILO IN LEGNO**  
68 mm

**MATERIAL / MATERIAL / MATERIALE**  
spruce / Fichte / abete

**ENERGY EFFICIENCY / WÄRMEDÄMMWERT/  
EFFICIENZA ENERGETICA**  
 $U_g = 1,1 \text{ W/m}^2\text{K}$ ,  $U_w = 1,3 \text{ W/m}^2\text{K}$

$U_w \leq 1,3$



### Jeloterm

**GLAZING / VERGLASUNG / VETRAGGIO**  
double glazing 4-16-4 / Doppelverglasung  
4-16-4 / vetro doppio 4-16-4

**WOODEN PROFILE / HOLZPROFIL /  
PROFILO IN LEGNO**  
68 mm

**MATERIAL / MATERIAL / MATERIALE**  
spruce, larch, oak / Fichte, Lärche, Eiche /  
abete, larice, rovere

**ENERGY EFFICIENCY / WÄRMEDÄMMWERT/  
EFFICIENZA ENERGETICA**  
 $U_g = 1,1 \text{ W/m}^2\text{K}$ ,  $U_w = 1,3 \text{ W/m}^2\text{K}$

## 3 > Eko



### Ekolight Premium

**GLAZING / VERGLASUNG / VETRAGGIO**  
double glazing 4-16-4 / Doppelverglasung  
4-16-4 / vetro doppio 4-16-4

**WOODEN PROFILE + ALU CLAD /  
HOLZPROFIL + ALUMASKE / PROFILO IN  
LEGNO + MASCHERA IN ALLUMINIO**  
85 mm

**MATERIAL / MATERIAL / MATERIALE**  
spruce / Fichte / abete

**ENERGY EFFICIENCY / WÄRMEDÄMMWERT/  
EFFICIENZA ENERGETICA**  
 $U_g = 0,9 \text{ W/m}^2\text{K}$ ,  $U_w = 1,1 \text{ W/m}^2\text{K}$

$U_w \leq 1,1$



### Ekolight

**GLAZING / VERGLASUNG / VETRAGGIO**  
double glazing 4-16-4 / Doppelverglasung  
4-16-4 / vetro doppio 4-16-4

**WOODEN PROFILE / HOLZPROFIL /  
PROFILO IN LEGNO**  
68 mm

**MATERIAL / MATERIAL / MATERIALE**  
spruce / Fichte / abete

**ENERGY EFFICIENCY / WÄRMEDÄMMWERT/  
EFFICIENZA ENERGETICA**  
 $U_g = 0,9 \text{ W/m}^2\text{K}$ ,  $U_w = 1,1 \text{ W/m}^2\text{K}$

$U_w \leq 1,1$



### Ekoterm

**GLAZING / VERGLASUNG / VETRAGGIO**  
triple glazing 4-10-4-10-4 / Dreifachver-  
glasung 4-10-4-10-4 / vetro triplo 4-10-4-10-4

**WOODEN PROFILE / HOLZPROFIL /  
PROFILO IN LEGNO**  
68 mm

**MATERIAL / MATERIAL / MATERIALE**  
spruce / Fichte / abete

**ENERGY EFFICIENCY / WÄRMEDÄMMWERT/  
EFFICIENZA ENERGETICA**  
 $U_g = 0,8 \text{ W/m}^2\text{K}$ ,  $U_w = 1,1 \text{ W/m}^2\text{K}$

## 2 > Jelostar



### Jelostar Premium

**GLAZING / VERGLASUNG / VETRAGGIO**  
triple glazing 4-14-4-14-4 / Dreifachverglasung 4-14-4-14-4 / vetro tripla 4-14-4-14-4

**WOODEN PROFILE + ALU CLAD / HOLZPROFIL + ALUMASKE / PROFILO IN LEGNO + MASCHERA IN ALLUMINIO**  
95 mm

**MATERIAL / MATERIAL / MATERIALE**  
spruce, larch, oak / Fichte, Lärche, Eiche / abete, larice, rovere

**ENERGY EFFICIENCY / WÄRMEDÄMMWERT / EFFICIENZA ENERGETICA**  
 $U_g = 0,6 \text{ W/m}^2\text{K}$ ,  $U_w = 0,89 \text{ W/m}^2\text{K}$

$U_w \leq 0,9$



### Jelostar

**GLAZING / VERGLASUNG / VETRAGGIO**  
triple glazing 4-14-4-14-4 / Dreifachverglasung 4-14-4-14-4 / vetro tripla 4-14-4-14-4

**WOODEN PROFILE / HOLZPROFIL / PROFILO IN LEGNO**  
78 mm

**MATERIAL / MATERIAL / MATERIALE**  
spruce, larch, oak / Fichte, Lärche, Eiche / abete, larice, rovere

**ENERGY EFFICIENCY / WÄRMEDÄMMWERT / EFFICIENZA ENERGETICA**  
 $U_g = 0,6 \text{ W/m}^2\text{K}$ ,  $U_w = 0,89 \text{ W/m}^2\text{K}$



### Jelostil

**GLAZING / VERGLASUNG / VETRAGGIO**  
triple glazing 4-14-4-14-4 / Dreifachverglasung 4-14-4-14-4 / vetro tripla 4-14-4-14-4

**WOODEN PROFILE / HOLZPROFIL / PROFILO IN LEGNO**  
78 mm

**MATERIAL / MATERIAL / MATERIALE**  
spruce, larch, oak / Fichte, Lärche, Eiche / abete, larice, rovere

**ENERGY EFFICIENCY / WÄRMEDÄMMWERT / EFFICIENZA ENERGETICA**  
 $U_g = 0,6 \text{ W/m}^2\text{K}$ ,  $U_w = 0,89 \text{ W/m}^2\text{K}$

## 1 > Pasiv



### Pasivstar Premium

**GLAZING / VERGLASUNG / VETRAGGIO**  
triple glazing 4-14-4-14-4 / Dreifachverglasung 4-14-4-14-4 / vetro tripla 4-14-4-14-4

**WOODEN PROFILE + ALU CLAD / HOLZPROFIL + ALUMASKE / PROFILO IN LEGNO + MASCHERA IN ALLUMINIO**  
95 mm

**MATERIAL / MATERIAL / MATERIALE**  
spruce, larch, oak / Fichte, Lärche, Eiche / abete, larice, rovere

**ENERGY EFFICIENCY / WÄRMEDÄMMWERT / EFFICIENZA ENERGETICA**  
 $U_g = 0,6 \text{ W/m}^2\text{K}$ ,  $U_w = 0,80 \text{ W/m}^2\text{K}$

$U_w \leq 0,8$



### Pasivstar

**GLAZING / VERGLASUNG / VETRAGGIO**  
triple glazing 4-14-4-14-4 / Dreifachverglasung 4-14-4-14-4 / vetro tripla 4-14-4-14-4

**WOODEN PROFILE / HOLZPROFIL / PROFILO IN LEGNO**  
78 mm

**MATERIAL / MATERIAL / MATERIALE**  
spruce, larch, oak / Fichte, Lärche, Eiche / abete, larice, rovere

**ENERGY EFFICIENCY / WÄRMEDÄMMWERT / EFFICIENZA ENERGETICA**  
 $U_g = 0,6 \text{ W/m}^2\text{K}$ ,  $U_w = 0,80 \text{ W/m}^2\text{K}$



### Jelopasiv Premium

**GLAZING / VERGLASUNG / VETRAGGIO**  
triple glazing 4-18-4-18-4 / Dreifachverglasung 4-18-4-18-4 / vetro tripla 4-18-4-18-4

**WOODEN PROFILE + ALU CLAD / HOLZPROFIL + ALUMASKE / PROFILO IN LEGNO + MASCHERA IN ALLUMINIO**  
112 mm

**MATERIAL / MATERIAL / MATERIALE**  
spruce / Fichte / abete

**ENERGY EFFICIENCY / WÄRMEDÄMMWERT / EFFICIENZA ENERGETICA**  
 $U_g = 0,6 \text{ W/m}^2\text{K}$ ,  $U_w \leq 0,8 \text{ W/m}^2\text{K}$

$U_w \leq 0,8$



### Jelopasiv

**GLAZING / VERGLASUNG / VETRAGGIO**  
triple glazing 4-18-4-18-4 / Dreifachverglasung 4-18-4-18-4 / vetro tripla 4-18-4-18-4

**WOODEN PROFILE / HOLZPROFIL / PROFILO IN LEGNO**  
110 mm

**MATERIAL / MATERIAL / MATERIALE**  
spruce / Fichte / abete

**ENERGY EFFICIENCY / WÄRMEDÄMMWERT / EFFICIENZA ENERGETICA**  
 $U_g = 0,6 \text{ W/m}^2\text{K}$ ,  $U_w = 0,72 \text{ W/m}^2\text{K}$



12

13

## 4 > Jeloterm



$U_w \leq 1,3$



### Jelotech

#### GLAZING / VERGLASUNG / VETRO

double glazing 4-16-4 / Doppelverglasung  
4-16-4 / vetro doppio 4-16-4

#### WOODEN PROFILE / HOLZPROFIL / PROFILO IN LEGNO

68 mm

#### MATERIAL / MATERIAL / MATERIALE

spruce / Fichte / abete

#### ENERGY EFFICIENCY / WÄRMEDÄMMWERT/ EFFICIENZA ENERGETICA

$U_g = 1,1 \text{ W/m}^2\text{K}$ ,  $U_w = 1,3 \text{ W/m}^2\text{K}$



### Jelotech

- Available in finger jointed spruce wood.
- One built-in rain protection profile and two window seals.
- This window is recommended for those who favour wood and want a cost-effective solution.

- Das Fenster aus keilverzinkten Fichtenholz.
- Mit einem miteiner Regenschutzschiene und zwei Dichtungen.
- Das Fenster ist für diejenigen zu empfehlen, die auf Holz schwören und gleichzeitig eine preislich günstige Lösung wünschen.

- Disponibile in legno di abete giuntato.
- Dotata di un gocciolatoio e di due guarnizioni.
- La finestra è consigliata a chi ama il legno e vuole trovare allo stesso tempo una soluzione conveniente.

## Jeloterm & Jeloterm Premium

- Made of laminated spruce, larch and oak wood.
- Two built-in window seals and rain protection profiles on the window casement and on the window frame.
- Aluminium cladding on a wood-aluminium window.
- An easy and affordable solution that will ensure energy efficiency.

- Das Fenster ist aus lamellierten Fichten, Lärchen- und Eichenholz hergestellt.
- Mit einem Regenschutzschiene und zwei Dichtungen an dem Fensterflügel und dem Rahmen.
- Alumaske auf dem Holz-Alu-Fenster.
- Eine einfache und preislich günstige Lösung für die Gewährleistung der Energiesparsamkeit.

- Disponibile in legno laminato di abete, larice e rovere.
- Dotata di gocciolatoio sul battente e sulla parte inferiore del telaio della finestra.
- Maschera in alluminio sulla finestra in legno-alluminio.
- Soluzione facile e conveniente per garantire il risparmio energetico.



## Jeloterm Premium

### GLAZING / VERGLASUNG / VETRO

double glazing 4-16-4 / Doppelverglasung 4-16-4 / vetro doppio 4-16-4

### WOODEN PROFILE + ALU CLAD / HOLZPROFIL + ALUMASKE / PROFILO IN LEGNO + MASCHERA IN ALLUMINIO

85 mm

### MATERIAL / MATERIAL / MATERIALE

spruce, larch, oak / Fichte, Lärche, Eiche / abete, larice, rovere

### ENERGY EFFICIENCY / WÄRMEDÄMMWERT/ EFFICIENZA ENERGETICA

$U_g = 1,1 \text{ W/m}^2\text{K}$ ,  $U_w = 1,3 \text{ W/m}^2\text{K}$



14

15



## Jeloterm

### GLAZING / VERGLASUNG / VETRO

double glazing 4-16-4 / Doppelverglasung 4-16-4 / vetro doppio 4-16-4

### WOODEN PROFILE / HOLZPROFIL / PROFILO IN LEGNO

68 mm

### MATERIAL / MATERIAL / MATERIALE

spruce, larch, oak / Fichte, Lärche, Eiche / abete, larice, rovere

### ENERGY EFFICIENCY / WÄRMEDÄMMWERT/ EFFICIENZA ENERGETICA

$U_g = 1,1 \text{ W/m}^2\text{K}$ ,  $U_w = 1,3 \text{ W/m}^2\text{K}$

## Ekolight Premium

**GLAZING / VERGLASUNG / VETRO**  
double glazing 4-16-4 / Doppelverglasung  
4-16-4 / vetro doppio 4-16-4

**WOODEN PROFILE + ALU CLAD / HOLZPRO-  
FIL + ALUMASKE / PROFILO IN LEGNO +  
MASCERA IN ALLUMINIO**  
85 mm

**MATERIAL / MATERIAL / MATERIALE**  
spruce / Fichte / abete

**ENERGY EFFICIENCY / WÄRMEDÄMMWERT/  
EFFICIENZA ENERGETICA**  
 $U_g = 0,9 \text{ W/m}^2\text{K}$ ,  $U_w = 1,1 \text{ W/m}^2\text{K}$



## Ekolight

**GLAZING / VERGLASUNG / VETRO**  
double glazing 4-16-4 / Doppelverglasung  
4-16-4 / vetro doppio 4-16-4

**WOODEN PROFILE / HOLZPROFIL /  
PROFILO IN LEGNO**  
68 mm

**MATERIAL / MATERIAL / MATERIALE**  
spruce / Fichte / abete

**ENERGY EFFICIENCY / WÄRMEDÄMMWERT/  
EFFICIENZA ENERGETICA**  
 $U_g = 0,9 \text{ W/m}^2\text{K}$ ,  $U_w = 1,1 \text{ W/m}^2\text{K}$



## Ekolight & Ekolight Premium

- Made of laminated spruce wood.
- Lighter than comparable triple glazed windows.
- Double glazing with a special low-emission coating, which improves thermal insulation.

- Das Fenster ist aus lamellierten Fichtenholz hergestellt.
- Konstruktionsbedingt leichter als ein vergleichbares Fenster mit Dreifachverglasung.
- Die Gläser mit spezieller Niedrigemissionsbeschichtung tragen zu der verbesserten Wärmedämmung des Fensters bei.

- Disponibile in legno laminato di abete.
- La struttura è più leggera rispetto a finestre equivalenti a triplo strato di vetro.
- Il vetro con una speciale applicazione di emissione contribuisce ad un migliore isolamento termico delle finestre.





## Ekoterm

- Available in finger jointed spruce wood.
  - Triple glazing, which improves the window's insulation properties.
  - Two built-in window seals and rain protection profiles on the window casement and on the window frame.
- 
- Das Fenster aus keilverzinkten Fichtenholz.
  - Die Dreifachverglasung verbessert die Isolationseigenschaften.
  - Mit zwei Regenschutzschiemen und zwei Dichtungen an dem Fensterflügel und Rahmen.
- 
- Disponibile in legno di abete giuntato.
  - Il vetro a triplo strato migliora le caratteristiche di isolamento.
  - Dotata di due guarnizioni e due gocciolatoi sul battente e sulla parte inferiore del telaio della finestra.



## Ekoterm

### GLAZING / VERGLASUNG / VETRO

triple glazing 4-10-4-10-4 / Dreifachverglasung 4-10-4-10-4 / vetro tripla 4-10-4-10-4

### WOODEN PROFILE / HOLZPROFIL / PROFILO IN LEGNO

68 mm

### MATERIAL / MATERIAL / MATERIALE

spruce / Fichte / abete

### ENERGY EFFICIENCY / WÄRMEDÄMMWERT / EFFICIENZA ENERGETICA

$U_g = 0,8 \text{ W/m}^2\text{K}$ ,  $U_w = 1,1 \text{ W/m}^2\text{K}$

16

17

2 > Jelostar



## Jelostar & Jelostar Premium

- Made of laminated spruce, larch and oak wood.
- Triple glazing with a wider profile and space in between the panes of glass, which improves the window's insulation properties.
- Two built-in window seals and rain protection profiles on the wooden window casement and on the window frame. Aluminium cladding on wood-aluminium windows.

- Das Fenster ist aus lamellierten Fichten, Lärchen- und Eichenholz hergestellt.
- Die Dreifachverglasung mit breitem Profil und Glaszwischenraum verbessert die Isolationseigenschaften des Fensters.
- Mit zwei Regenschutzschienen und zwei Dichtungen an dem hölzernen Fensterflügel und dem Rahmen. Mit Aluverkleidung auf dem Holz-Alu-Fenster.

- Disponibile in legno laminato di abete, larice e rovere.
- Il vetro a triplo strato con un profilo più ampio e lo spazio tra i vetri migliora le caratteristiche d'isolamento delle finestre.
- Dotata di due guarnizioni e 2 gocciolatoi sul battente e sulla parte inferiore del telaio della finestra. Maschera in alluminio sulla finestra in legno-alluminio.



## Jelostar Premium

### GLAZING / VERGLASUNG / VETRO

triple glazing 4-14-4-14-4 / Dreifachverglasung 4-14-4-14-4 / vetro tripla 4-14-4-14-4

### WOODEN PROFILE + ALU CLAD / HOLZPROFIL + ALUMASKE / PROFILO IN LEGNO + MASCHERA IN ALLUMINIO

95 mm

### MATERIAL / MATERIAL / MATERIALE

spruce, larch, oak / Fichte, Lärche, Eiche / abete, larice, rovere

### ENERGY EFFICIENCY / WÄRMEDÄMMWERT / EFFICIENZA ENERGETICA

$U_g = 0,6 \text{ W/m}^2\text{K}$ ,  $U_w = 0,89 \text{ W/m}^2\text{K}$



18

19

## Jelostar

### GLAZING / VERGLASUNG / VETRO

triple glazing 4-14-4-14-4 / Dreifachverglasung 4-14-4-14-4 / vetro tripla 4-14-4-14-4

### WOODEN PROFILE / HOLZPROFIL / PROFILO IN LEGNO

78 mm

### MATERIAL / MATERIAL / MATERIALE

spruce, larch, oak / Fichte, Lärche, Eiche / abete, larice, rovere

### ENERGY EFFICIENCY / WÄRMEDÄMMWERT / EFFICIENZA ENERGETICA

$U_g = 0,6 \text{ W/m}^2\text{K}$ ,  $U_w = 0,89 \text{ W/m}^2\text{K}$



## A stylish window with wooden cross-bars

Jelostil is a modern window with a traditional look, which brings a touch of warmth and cosiness to your house or apartment. The window is characterised by an interweaving of the past and future, a harmonious blend of modern technology and traditional methods.

- Jelostil is the perfect solution in the restoration of historical buildings and older houses.
- It is also recommended for those who fancy a cosy rustic style as well as for those who want to bring the luxury of the bourgeois and aristocratic lifestyle to your home.

## Stilfenster mit Holzsprossen

Jelostil ist ein modernes Fenster mit traditionellem Aussehen, das einen Hauch von Gemütlichkeit und Wärme in das Haus oder die Wohnung bringt. Das Fenster zeichnet sich durch die Verknüpfung von Zukunft und Vergangenheit sowie durch den Einklang von moderner Technologie und Tradition aus.

- Es ist eine ideale Lösung für die Renovierung denkmalgeschützter Objekte sowie älterer Häuser.
- Es ist sowohl für diejenigen empfehlenswert, die ihre Inspiration im rustikalen Stil gefunden haben, als auch für alle, die in ihr Zuhause die Pracht des alten bürgerlichen und aristokratischen Lebensstils integrieren möchten.

## Finestra con inglesine in legno

Jelostil è una finestra moderna dall'aspetto tradizionale che dona alla casa o all'appartamento un tocco di familiarità e calore. La finestra è caratterizzata da un intreccio del futuro e del passato, dall'armonia tra la tecnologia moderna e la tradizione.

- La finestra Jelostil è la soluzione ideale per la ricostruzione di monumenti protetti e di case antiche.
- È consigliabile sia per coloro che trovano l'ispirazione nello stile rustico, sia per quelli che vogliono portare nella loro casa il lusso dello stile di vita vecchio borghese e aristocratico.



20

21



## Jelostil

### GLAZING / VERGLASUNG / VETRO

triple glazing 4-14-4-14-4 / Dreifachverglasung  
4-14-4-14-4 / vetro triplo 4-14-4-14-4

### WOODEN PROFILE / HOLZPROFIL / PROFILO IN LEGNO

78 mm

### MATERIAL / MATERIAL / MATERIALE

spruce, larch, oak / Fichte, Lärche, Eiche / abete,  
larice, rovere

### ENERGY EFFICIENCY / WÄRMEDÄMMWERT/ EFFICIENZA ENERGETICA

$U_g = 0,6 \text{ W/m}^2\text{K}$ ,  $U_w = 0,89 \text{ W/m}^2\text{K}$

# 1 > Pasiv

## Pasivstar Premium

### GLAZING / VERGLASUNG / VETRO

triple glazing 4-14-4-14-4 / Dreifachverglasung  
4-14-4-14-4 / vetro tripla 4-14-4-14-4

### WOODEN PROFILE + ALU CLAD / HOLZPROFIL + ALUMASKE / PROFILO IN LEGNO + MASCHERA IN ALLUMINIO

95 mm

### MATERIAL / MATERIAL / MATERIALE

spruce, larch, oak / Fichte, Lärche, Eiche / abete, larice, rovere

### ENERGY EFFICIENCY / WÄRMEDÄMMWERT / EFFICIENZA ENERGETICA

$U_g = 0,6 \text{ W/m}^2\text{K}$ ,  $U_w = 0,80 \text{ W/m}^2\text{K}$



## Pasivstar

### GLAZING / VERGLASUNG / VETRO

triple glazing 4-14-4-14-4 / Dreifachverglasung  
4-14-4-14-4 / vetro tripla 4-14-4-14-4

### WOODEN PROFILE / HOLZPROFIL / PROFILO IN LEGNO

78 mm

### MATERIAL / MATERIAL / MATERIALE

spruce, larch, oak / Fichte, Lärche, Eiche / abete, larice, rovere

### ENERGY EFFICIENCY / WÄRMEDÄMMWERT / EFFICIENZA ENERGETICA

$U_g = 0,6 \text{ W/m}^2\text{K}$ ,  $U_w = 0,80 \text{ W/m}^2\text{K}$



## Pasivstar & Pasivstar Premium

- Low-energy and eco-friendly windows, suitable for low-energy houses.
- Spruce profiles, filled with insulating foam to improve the window's thermal insulation.
- Ein niedrigergetisches und umweltfreundliches Fenster für Niedrigenergiehäuser.
- Lamellierte Fensterprofile aus Holz, die mit Schaum gefüllt sind und die Wärmedämmfähigkeit des Fensters verbessern.
- Finestra a basso consumo di energia che rispetta l'ambiente, adatta per le case a basso consumo energetico.
- Profili in legno laminati, ripieni di schiuma isolante per migliorare l'isolamento termico della finestra.

## Jelopasiv & Jelopasiv Premium

- The best thermal insulation.
- These passive windows are intended for energy self-sufficient and low-energy houses and buildings.
- Their high performance insulating frame and glass help achieve the best thermal properties.

- Beste Wärmedämmung.
- Das Passivfenster ist für Passivhäuser sowie Niedrigenergiehäuser und Objekte bestimmt.
- Der Rahmen und das Glas mit besten Isolationseigenschaften tragen zur Erreichung der besten Wärmedämmeigenschaften bei.

- Il migliore isolamento termico.
- Una finestra passiva ideata per case ed edifici energeticamente autosufficienti e a basso consumo energetico.
- Cornice e vetro altamente isolanti contribuiscono a ottenere le migliori caratteristiche termiche.



## Jelopasiv Premium

### GLAZING / VERGLASUNG / VETRO

triple glazing 4-18-4-18-4 / Dreifachverglasung  
4-18-4-18-4 / vetro tripla 4-18-4-18-4

### WOODEN PROFILE + ALU CLAD / HOLZPRO- FIL + ALUMASKE / PROFILO IN LEGNO + MASCHERA IN ALLUMINIO

112 mm

### MATERIAL / MATERIAL / MATERIALE

spruce / Fichte / abete

### ENERGY EFFICIENCY / WÄRMEDÄMMWERT/ EFFICIENZA ENERGETICA

$U_g = 0,6 \text{ W/m}^2\text{K}$ ,  $U_w \leq 0,8 \text{ W/m}^2\text{K}$

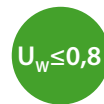

22

23



## Jelopasiv

### GLAZING / VERGLASUNG / VETRO

triple glazing 4-18-4-18-4 / Dreifachverglasung  
4-18-4-18-4 / vetro tripla 4-18-4-18-4

### WOODEN PROFILE / HOLZPROFIL / PROFILO IN LEGNO

110 mm

### MATERIAL / MATERIAL / MATERIALE

spruce / Fichte / abete

### ENERGY EFFICIENCY / WÄRMEDÄMMWERT/ EFFICIENZA ENERGETICA

$U_g = 0,6 \text{ W/m}^2\text{K}$ ,  $U_w = 0,72 \text{ W/m}^2\text{K}$





Sliding doors / Schiebetüren / Porte scorrevoli

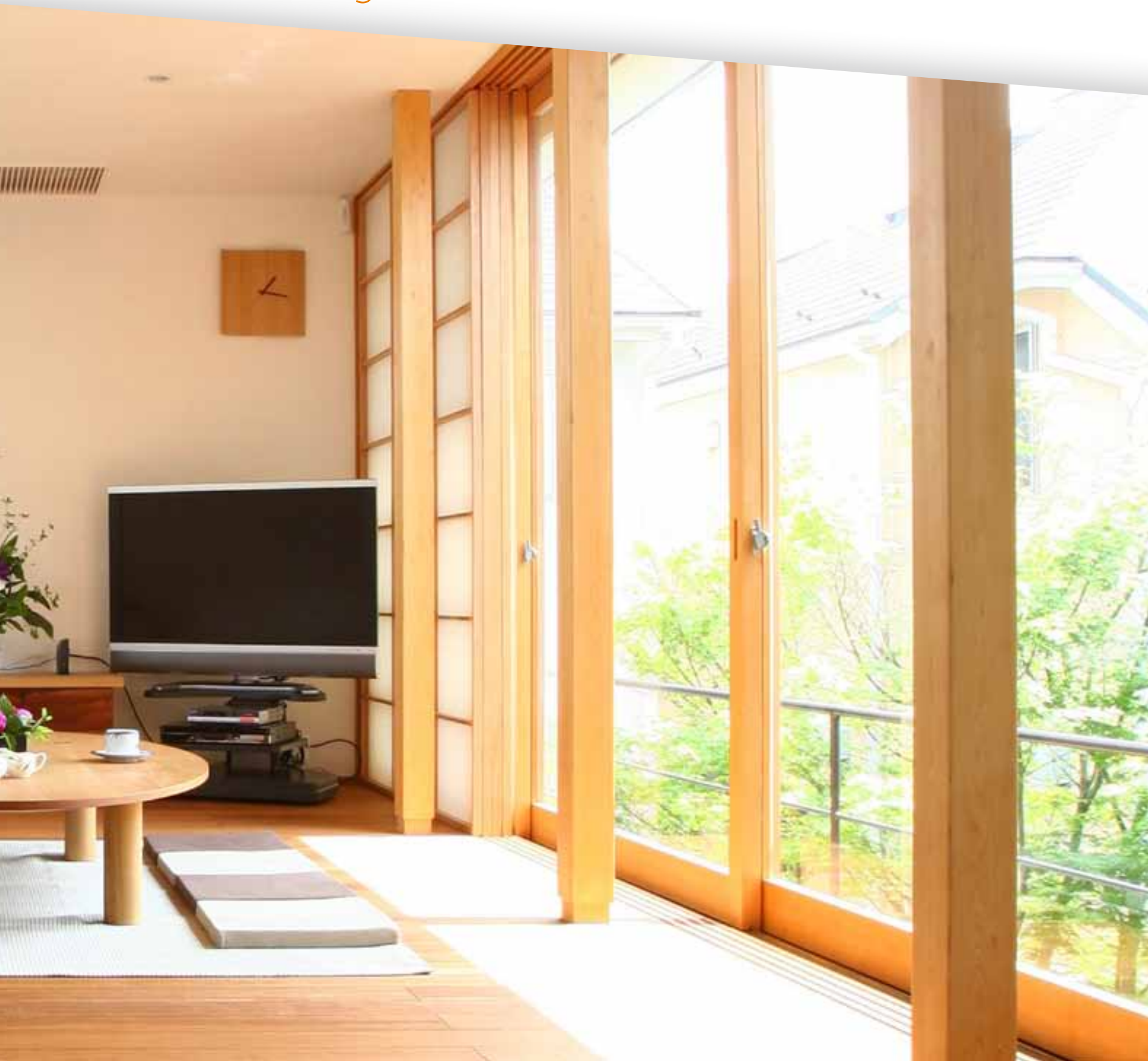



Our sliding doors are made from spruce, oak or larch wood. The lifting-sliding and tilting-sliding doors are also available in the wood-aluminium version. Our sliding doors are distinguished by their technologically advanced structure and quality frame. Their glazing system and structural solutions helps keep out the winter cold and the summer heat.

Schiebetüren stellen wir aus Fichten-, Lärchen- oder Eichenholz her.

Hebeschiebwände und Schiebekippwände stellen wir auch in der Ausführung Holz-Aluminium her. Die Panoramawände von Jelovica zeichnen sich durch eine technisch ausgereifte Konstruktion und qualitativ hochwertige Beschläge aus. Das Verglasungssystem und die konstruktiven Lösungen gewährleisten, dass der Raum im Winter vor Kälte geschützt ist und im Sommer keine Hitze ins Innere eindringt.

Le porte scorrevoli sono realizzate in legno di abete, rovere o larice. Quelle sollevabili e quelle scorrevoli inclinabili possono essere realizzate anche in versione legno-alluminio. Le porte scorrevoli Jelovica si distinguono per la loro struttura ad alta tecnologia e per le guarnizioni di alta qualità. Il sistema di vetraggio e le soluzioni di costruzione delle porte scorrevoli garantiscono che lo spazio sia protetto dal freddo invernale e che durante l'estate il calore non penetri all'interno.

**Tilt and slide doors**  
Parallel schiebekipptür  
Scorrevole complanare

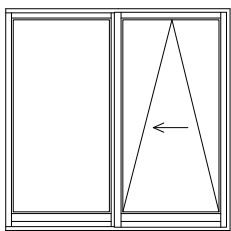
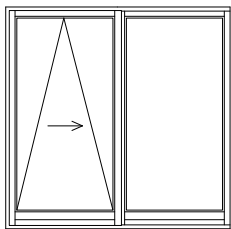

**Sliding folding Door**  
Faltschiebekipptüren  
Scorrevole a fisarmonica

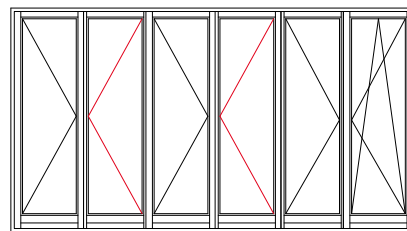
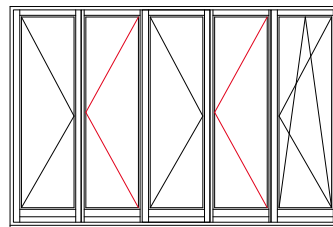
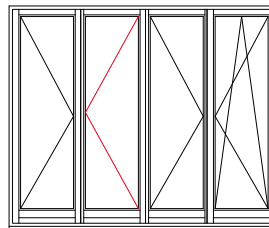
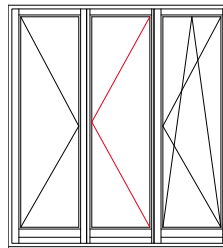

**Lift and slide doors A**  
Hebeschiebetüren A  
Alzante scorrevole A

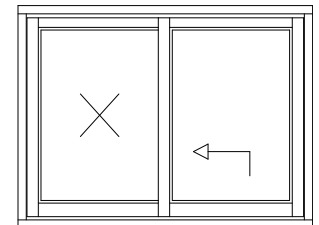
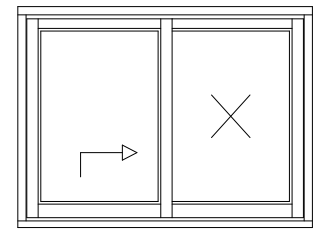

**Lift and slide doors G**  
Hebeschiebetüren G  
Alzante scorrevole G

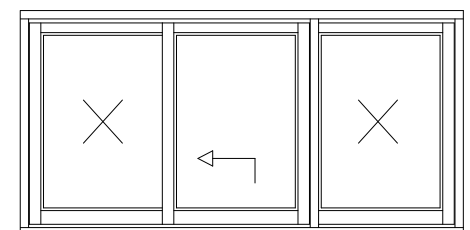
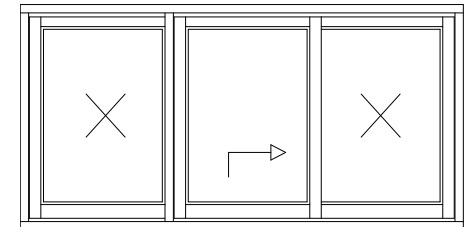

**Lift and slide doors C**  
Hebeschiebetüren C  
Alzante scorrevole C

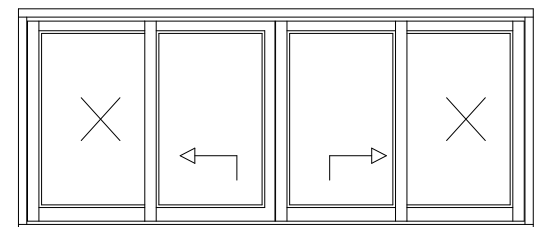

26

27





Doors / Türen / Porte

# Futura Modern



## Futura Modern & Futura Elegance

Entrance doors are available in top coats, spruce, oak or larch.

**Futura Modern:** without a glazing frame on the outer surface of the door.

**Futura Elegance:** entrance doors with integrated three-layer glass, veneer runs horizontally.

Die Türen stehen in Abdeckfarben, Fichte, Eiche und Lärche zur Verfügung.

**Futura Modern:** Standardausführung ohne Glasleisten an der Türaußenseite.

**Futura Elegance:** Eingangstüren mit integriertem Dreifachverglasung.

Le porte d'ingresso sono a disposizione in copertura colorata, legno d'abete, rovere o legno di larice.

**Futura Modern:** senza cornice vetrata sulla parte esterna della porta.

**Futura Elegance:** Le porte d'ingresso con integrato il vetro a tre strati, l'impiallacciatura è disposta trasversalmente.

Images are for illustrative purposes only.  
Die Abbildungen sind symbolisch.  
Le immagini delle porte sono simboliche.



FM 300



FM 301



FM 303

# Futura Elegance



30

31



FE 400



FE 401

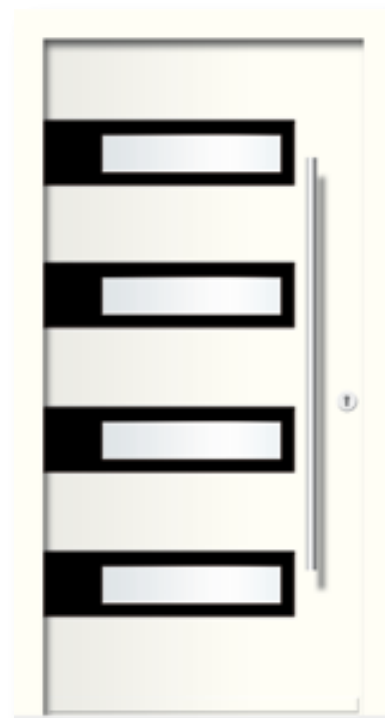

FE 402

# Futura Trend



## Futura Trend

Futura Trend doors are available in top coats, spruce, oak and larch wood. Standard design with wooden glazed frames on the outer side of the doors. You can also choose a stainless steel frame on the outer side of the door.

Die Holzeingangstüren Futura Trend stehen in Abdeckfarben, Fichte, Eiche und Lärche zur Verfügung. Standardausführung mit Glasleisten an der Türaußenseite. Sie können sich auch für den Inox-Rahmen auf der Türaußenseite entscheiden.

Le porte d'ingresso Futura Trend sono a disposizione in copertura colorata, legno d'abete, rovere e legno di larice. Realizzazione standard con fermavetri in legno sulla parte esterna della porta. È possibile scegliere anche la cornice in acciaio inox sulla parte esterna della porta.

Images are for illustrative purposes only.  
Die Abbildungen sind symbolisch.  
Le immagini delle porte sono simboliche.



FT 207



FT 211



FT 214





FT 200



FT 201



FT 202

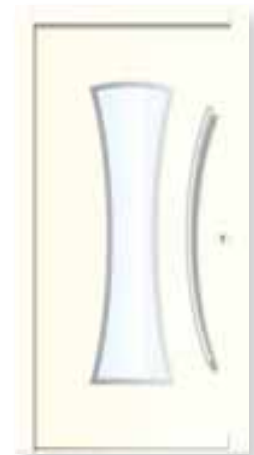

FT 203



FT 204

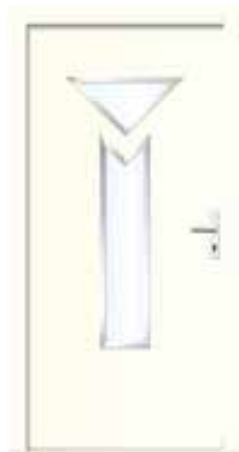

FT 205

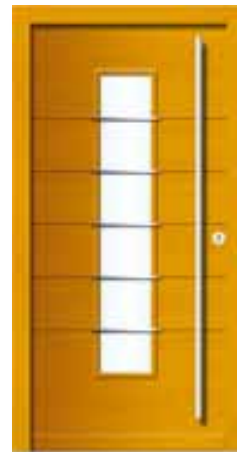

FT 206



FT 208



FT 209



FT 210



FT 212



FT 213

# Futura Premium



## Futura Premium

Wooden aluminium entrance doors Futura Premium are available in top coats, spruce, oak and larch wood. The aluminium mask protects the doors from harmful weather conditions and gives them a modern look.

Die Holz- und Alueingangstüren Futura Premium stehen in Abdeckfarben, Fichte, Eiche und Lärche zur Verfügung. Die Aluschale schützt die Tür vor schädlichen Witterungseinflüssen und verleiht ihr ein modernes Aussehen.

Le porte d'ingresso in legno e alluminio Futura Premium sono a disposizione in copertura colorata, legno d'abete, rovere e legno di larice. La maschera in alluminio protegge la porta dalle dannose condizioni meteorologiche e le dona un aspetto moderno.

Images are for illustrative purposes only.  
Die Abbildungen sind symbolisch.  
Le immagini delle porte sono simboliche.



FP 507



FP 506

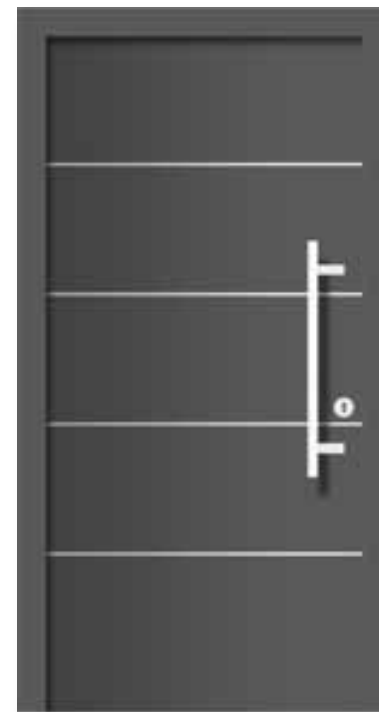

FP 501



FP 503



FP 504



FP 505



FP 502



# Futura Classic



## Futura Classic

Futura Classic doors are high-quality wooden entrance doors with a traditional design. You can choose between spruce, oak, larch and painted doors.

This line consists of wooden doors with glass panels and polyurethane foam insulation. The veneer runs vertically.

Die Eingangstüren Futura Classic aus Holz sind qualitativ hochwertige Türen mit traditionellen Formen. Die Türen stehen in deckenden Farben sowie in Fichte, Eiche und Lärche zur Verfügung. Serienmäßige Ausführung mit verglastem Rahmen aus Holz und einer Isolationsfüllung. Das Furnier verläuft vertikal.

Le porte d'ingresso in legno Futura Classic sono porte di alta qualità dalle forme tradizionali. È possibile scegliere la porta nel colore di copertura, abete, rovere e larice.

Realizzazione tipica con cornici in legno per i vetri e ripieno di materiale isolante. Impiallacciatura verticale.

Images are for illustrative purposes only.  
Die Abbildungen sind symbolisch.  
Le immagini delle porte sono simboliche.



FC 102



FC 103



FC 109



FC 100



FC 101



FC 104



FC 106



FC 107



FC 108



FC 110



FC 111

# Evergreen



## Evergreen

Evergreen solid wood entrance doors are a perfect combination of durability and the beauty of wood, and of technological progress and the heritage of past generations. They are made of high-quality laminated timber.

Model T 411 is available in oak and model V 241 is available in spruce.

Die Vollholzeingangstür Evergreen erreicht die Harmonie zwischen der Beständigkeit und der Schönheit von Holz sowie zwischen dem technologischen Fortschritt und dem Erbe der älteren Generationen. Sie wird aus hochwertigem Lamellenholz hergestellt. Das Modell T 411 ist in Eiche und das Modell V 241 in Fichte lieferbar.

Le porte d'ingresso in legno massello Evergreen raggiungono l'armonia tra la resistenza e la bellezza del legno, tra il progresso tecnologico e il patrimonio delle generazioni passate. Sono realizzate in legno lamellare di alta qualità. Il modello T 411 è disponibile in rovere e il modello V 241 in abete.

Images are for illustrative purposes only.  
Die Abbildungen sind symbolisch.  
Le immagini delle porte sono simboliche.



V 241



T 411



## Standard dimensions Standardabmessungen Dimensioni standard

### PRODUCT / PRODUKT / PRODOTTO

	Single-wing entrance door / einflügelige Eingangstüren / Porta d'ingresso a un battente	Double-wing entrance door / zweiflügelige Eingangstüren / Porta d'ingresso a due battenti
<b>WIDTH / BREITE / THICKNESS</b>	940-1135 mm	1600-2100 mm
<b>HEIGHT / HÖHE / ALTEZZA</b>	2030-2200 mm	2030-2200 mm
<b>THICKNESS / TIEFE / SPESSORE</b>	68 mm	68 mm

Thermal conductivity of the door:  $U_d \leq 1,6 \text{ W/m}^2\text{K}$   
 Wärmedämmwert der Türen  $U_d \leq 1,6 \text{ W/m}^2\text{K}$   
 Conducibilità termica della porta  $U_d \leq 1,6 \text{ W/m}^2\text{K}$

### Door swing direction Türöffnungsrichtung Senso d'apertura della porta

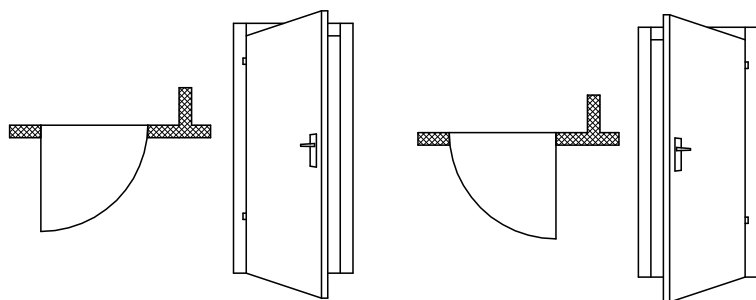

Left / Links / Sinistra

Right / Rechts / Destra

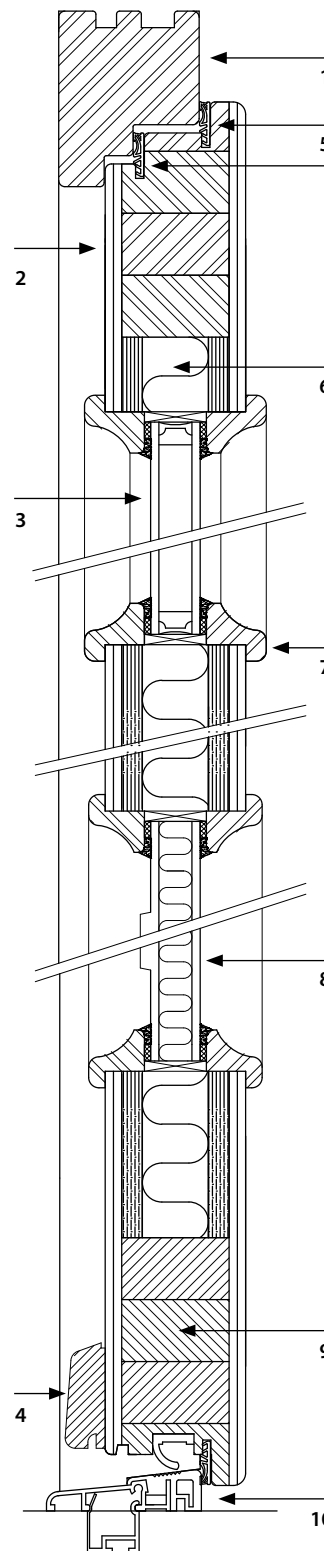

### Vertically cut entrance door Vertikaler Querschnitt der Eingangstüren Sezione verticale della porta d'ingresso

**1**  
doorframe (85-68mm) made of laminated wood with veneer edge banding /  
Türrahmen 85-68 mm aus lamelliertem Holz mit Furnier-Randleiste /  
stipite 85-68 mm in legno lamellare con incollatura

**2**  
veneered plywood with an aluminium vapour barrier on both sides of the wings /  
Furniertes Sperrholz aus Alu-Dampfsperre auf beiden Türseiten /  
pannello multistrato impiallacciato con barriera al vapore in alluminio su entrambi i lati dell'ala

**3**  
glass / Glas / vetro

**4**  
rain protection profile / Abtropfleiste /  
asta di protezione contro la pioggia

**5**  
silicone sealant / Silikondichtung /  
guarnizione in silicone

**6**  
core thermal insulation: polyurethane (PUR) foam /  
Isolationskern – harter wärmedämmender PUR-Schaum /  
nucleo isolante -duro schiuma PUR termoisolante

**7**  
glass panelling / Verglasungsleiste /  
asta di invetriatura

**8**  
filling / Füllung / ripieno

**9**  
sandwich frame made of glued wood /  
Sandwichrahmen aus Verbundholz /  
tamburato in legno lamellare

**10**  
Weser threshold /  
Weser-Bodenschwellenprofil /  
Soglia Weser

38

39



Spruce / Fichte / Abete – Fir / Tanne / Abete bianco



\* Special editions are only for windows / Gültig nur für Fenster / Versioni speciali disponibili solo per le finestre

Larch / Lärche / Rovere



Oak / Eiche / Larice







Aluminium / Aluminium / Alluminio

RAL 9016 MAT	RAL 8028 MAT	SILVA 03	SILVA 05	ROSSA 01
VERDA 05	DOUGLAS 1	DOUGLAS 2	DOUGLAS 3	GOLDEN OAK
KIRSCH 1	KIRSCH 3	DOUGLAS 6	WENGE	AZZURA 01
AZZURA 05	BIANCA 03	GS PED 2	GS PED 3	GS PED 4
GS PED 0	NERA 03	SILVA 01	TERRA 01	TERRA 02
TERRA 03	TERRA 05	TERRA 07	ANTICO DUNKELGRAU	ANTICO GRUN
ANTICO HELLGRAU	ANTICO WEISS	GS PD ALPHA	GS PD BETA	GS PD GAMMA
GS PD DELTA	GS PD ETA	GS PD ZETA	GS PD EPSILON	GS PED 1

40

41







**JELOVICA okna d.o.o.**

Kidričeva cesta 58  
4220 Škofja Loka  
Slovenia

**T:** +386 4 51 13 000

**F:** +386 4 51 32 761

**E:** info@jelovica.si

**www.jelovica.si**

**SALES / VERKAUF / VENDITE**

Delavska 24  
4208 Šenčur  
Slovenia

**T:** +386 4 511 33 99

**F:** +386 4 513 42 16

**E:** sales@jelovica.si